

# Chest Tube Management

Two (2.0) Contact Hours

**Course Expires:** 12/31/2020

First Published: 08/30/2007

Updated: 08/30/2010

Updated: 11/01/2013

Reproduction and distribution of these materials is prohibited without an Rn.com content licensing agreement.

Copyright © 2013 by RN.com.  
All Rights Reserved.

## Acknowledgments

**RN.com acknowledges the valuable contributions of...**

...**Nadine Salmon, MSN, BSN, IBCLC** is the Clinical Content Manager for RN.com. She is a South African trained Registered Nurse, Midwife and International Board Certified Lactation Consultant. Nadine obtained an MSN at Grand Canyon University, with an emphasis on Nursing Leadership. Her clinical background is in Labor & Delivery and Postpartum nursing, and she has also worked in Medical Surgical Nursing and Home Health. Nadine has work experience in three countries, including the United States, the United Kingdom and South Africa. She worked for the international nurse division of American Mobile Healthcare, prior to joining the Education Team at RN.com. Nadine is a nurse planner for RN.com and is responsible for all clinical aspects of course development. She updates course content to current standards, and develops new course materials for RN.com.

...**Shelley Lynch, MS, RN, CCRN**, contributing author of Chest Tubes. Shelley has over 10 years of critical care nursing experience. She completed her Bachelors of Science in Nursing from Hartwick College and her Masters of Science in Nursing with a concentration in education from Grand Canyon University. Shelley worked in a variety of intensive care units in some of the top hospitals in the United States including: Johns Hopkins Medical Center, Massachusetts General Hospital, New York University Medical Center, Tulane Medical Center, and Beth Israel Deaconess Medical Center. She is the author of RN.com's: Diabetes Overview, Thrombolytic Therapy for Acute Ischemic Stroke: t-PA/Alteplase, ICP Monitoring, Abdominal Compartment Syndrome, Chest Tube Management, Acute Coronary Syndrome: A Spectrum of Conditions and Emerging Therapies, Mechanical Ventilation, Procedural Sedation & Analgesia and Pulmonary Artery Catheter & Hemodynamic Values.

Shelley is a member of the American Association of Critical Care Nurses (AACN) and National League of Nursing (NLN). She was inducted in Sigma Theta Tau International Honor Society. She is currently

an Advance Cardiac Life Support (ACLS) and Basic Life Support (BLS) Instructor. She has her Critical Care Registered Nurse (CCRN) and her Trauma Nurse Core Curriculum (TNCC) certifications.

...**Kelly Muck, MPH**, contributing author of *Chest Tubes*.

## Conflict of Interest

RN.com strives to present content in a fair and unbiased manner at all times, and has a full and fair disclosure policy that requires course faculty to declare any real or apparent commercial affiliation related to the content of this presentation. Note: Conflict of Interest is defined by ANCC as a situation in which an individual has an opportunity to affect educational content about products or services of a commercial interest with which he/she has a financial relationship.

The author of this course does not have any conflict of interest to declare.

The planners of the educational activity have no conflicts of interest to disclose.

There is no commercial support being used for this course.

## Purpose & Objectives

The purpose of Chest Tube Management is to understand the use of chest tubes and the conditions that require their use. This course is designed to provide healthcare professionals with information about chest tubes and the management of chest drainage systems.

After successful completion of this course, you will be able to:

1. Identify indications for the use of chest tubes and accompanying signs and symptoms.
2. Describe the risks/complications associated with chest tubes and chest drainage units (CDUs).
3. Identify how to prepare/assist with the insertion of a chest tube.
4. Describe the monitoring of chest tubes and chest drainage systems.
5. Describe considerations in caring for the patient who has a chest tube, including chest tube maintenance.
6. Identify factors that indicate when it is appropriate to discontinue the use of a chest tube.
7. Describe how to assist with discontinuation of a chest tube.

## Introduction

Breathing is automatic. We don't usually think too much about it unless we develop a problem. Lack of adequate ventilation and impairment of our respiratory system can quickly become life-threatening. Healthcare professionals need to understand the basics of pulmonary function.

When interventions such as chest tube placement may be required to sustain life, it is essential that the healthcare professionals that provide care for these individuals have a strong understanding of pulmonary pathophysiology and factors that can influence the mechanics of effective air exchange.

It is also important that the healthcare professional understands the risks associated with chest tube insertion and drainage. Healthcare professionals also need to know how to assist with the preparation of the chest drainage unit, perform ongoing patient assessments, document appropriately, and troubleshoot possible problems related to the use of a chest tube.

## Definitions

**Pneumothorax:** A collection of air in the pleural space. Note that pneumothorax is the most common serious pleural complication in the Intensive Care Unit & the most common reason for inserting a chest tube.

**Tension pneumothorax:** Occurs when air accumulates in the pleura space to the point of causing a mediastinal shift pushing the heart, great vessels, trachea, and lungs toward the unaffected side of the thoracic cavity.

**Hemothorax:** A collection of blood in the pleural cavity.

**Hemopneumothorax:** An accumulation of both air and blood in the pleural cavity.

**Pleural effusion:** Is excessive fluid in the pleura cavity.

**Chylothorax:** Is the accumulation of lymphatic fluid in the pleural space.

**Empyema:** Is a collection of purulent material from an infection like pneumonia.

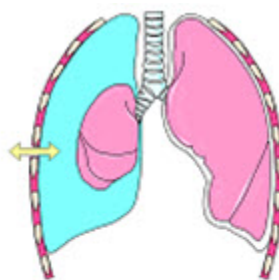

**Pneumothorax**

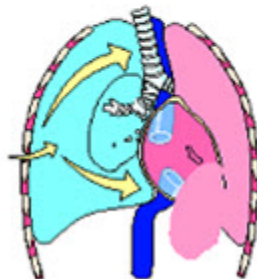

**Tension Pneumothorax**

### Signs and Symptoms of a Tension Pneumothorax include:

- Severe respiratory distress
- Tracheal deviation toward the unaffected side
- Cyanosis
- Muffled heart sounds
- Cardiac arrest

## Pleuropulmonary Anatomy, Physiology & Pathophysiology

A review of basic pleuropulmonary anatomy, physiology, and pathophysiology is necessary to facilitate a comprehensive understanding of chest tubes.

*Pleural space*: it is the cavity between the membrane lining of the lungs (visceral or pulmonary pleura) and the lining of the chest cavity (parietal pleura).

The pleura space functions to:

- Prevent friction between the outer lining of the lung and the inner lining of the thoracic cavity during respiration.
- Hold the two pleural surfaces together, creating negative pressure (a vacuum) that keeps the lungs expanded (Coughlin & Parchinsky, 2006).

The lungs are elastic and naturally tend to collapse or recoil, but in normal conditions, the pleural space causes the outer lining of the lung to adhere to the lining of the chest cavity, keeping the lungs expanded to proper position during inspiration and expiration (Roman & Mercado, 2006).

The pleural space is normally filled with approximately 50 mL of fluid, only enough to essentially provide a thin coating of fluid for the lubrication of the opposing surfaces. Small increases in volumes of air and/or fluid can be absorbed by the body, whereas larger volumes prevent the lung from expanding to its full potential. Breathing is obviously compromised when this excess air and/or fluid enter the pleural space. The lung may partially or completely collapse if a certain negative pressure threshold is not maintained in the pleural space. Obviously then, shortness of breath and increased respiratory rate and effort will be among the symptoms of such an event (Pruitt, 2008).

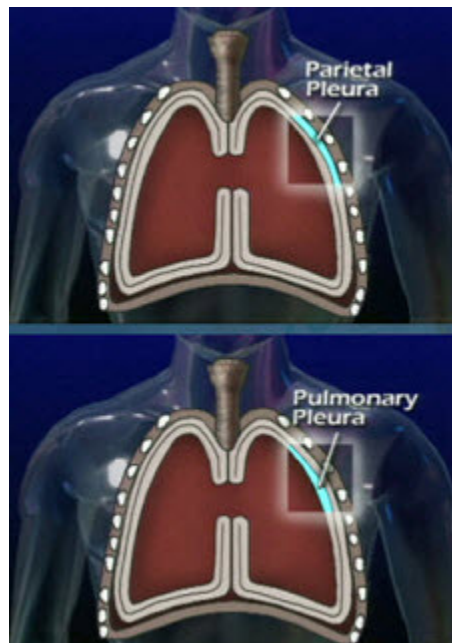

## Use of Chest Tubes

There are many clinical conditions that may necessitate the use of chest tubes. When there is an accumulation of positive pressure in the chest cavity (where it should normally be negative pressure

between pleurae), a patient will require chest drainage. Chest tubes may be inserted to drain body fluids or to facilitate the re-expansion of a lung.

No matter what the reason or underlying cause, chest tubes help to resolve the problems associated with large volumes of air or fluid that have collected in the pleural space.

When air or fluid enters the pleural space, the lung cannot expand properly. In some cases, chest tubes can also be used for certain therapy-related patient management as well. The use of chest tubes is not completely fail safe; complications can arise.

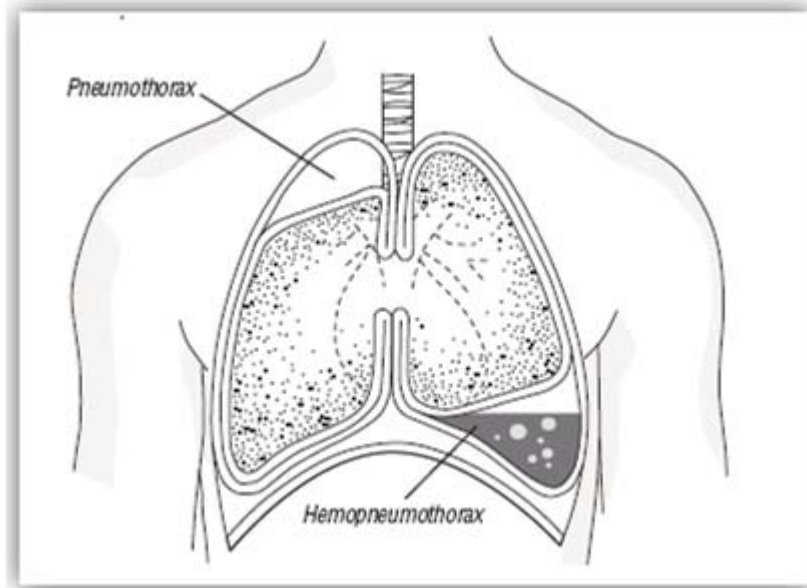

Image provided by Atrium Medical (2013) with permission.

### **Did You Know?**

**Chest tubes are also called tube thoracostomy or thoracic catheters.**

### **Indications for Chest Tubes**

There are various reasons for excess air and/or fluid in the pleural space. Specific common indications for chest tubes include:

- Pneumothorax (open and closed).
- Tension pneumothorax.
- Hemothorax.
- Hemopneumothorax.
- Pleural effusions.
- Chylothorax (a type of pleural effusion that results from lymphatic fluid (chyle) accumulating in the pleural cavity).
- Penetrating chest trauma.
- Pleural empyema (collection of purulent material in the lungs).

(Durai, Hoque, & Davies, 2010)

Other indications include:

- Excess air and/or fluid accumulation in the pleural space. For example, chest tubes are often placed

Material Protected by Copyright

after cardiac surgery to drain blood associated with the surgery (Doelken, 2010).

- Need for pleurodesis: Pleurodesis is a procedure used to treat patients with recurrent pleural effusions or recurrent pneumothorax. This procedure involves administering a sclerosing agent into the pleural space which causes the visceral and parietal pleura to adhere to each other without the thin coating of fluid between them. Chemical pleurodesis is a painful procedure, and patients are often pre-medicated with a sedative and analgesics. A local anesthetic may be instilled into the pleural space, or an epidural catheter may be placed for anesthesia.
- Chemotherapy administration: May be administered through a chest tube.

See below for common causes for air or fluid in the pleural space.

Causes	Examples
<b>Trauma</b>	Rib fractures (falls, auto accidents), Penetrating wounds (knife or gunshot wounds) or Blunt trauma (falls, auto accidents)
<b>Medical/Surgical complications</b>	High ventilator pressures, central line insertions, thoracic surgery, cardiopulmonary resuscitation (CPR), puncture of chest wall during surgery and lung or chest wall biopsy.
<b>Infection or disease</b>	Pneumonia cancer, emphysema, cystic fibrosis, tuberculosis, pulmonary embolism or fungal infections
<b>Cardiovascular Problems</b>	Heart failure

(English, & Leslie, 2006)



Eyelets on distal end of chest tubes. Wikipedia (2013).

*Please note!*

**The eyelets should not be visible after insertion.**

## Causes of Injury to the Chest Wall

The causes of the indications previously mentioned collectively include:

- Trauma
- Lung disorders
- Factors that compromise pulmonary function (e.g. COPD, smoking)
- Invasive pulmonary procedures (bronchoscopy)
- Cardiopulmonary resuscitation
- Surgical complication
- Complications from central line insertion
- Mechanical ventilation using positive end-expiratory pressure
- Purulent substances from an infection
- Any underlying clinical condition that results in excessive air/fluid in the pleural space (eg. pulmonary embolism and cancer)

**What's wrong with this picture?**

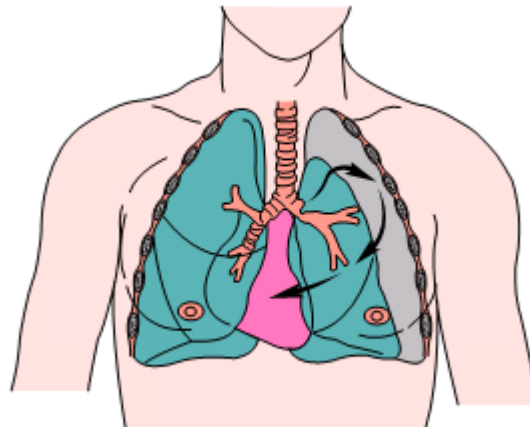

**Answer: Air has moved into the pleural space of the left lung causing pneumothorax and the potential for respiratory compromise.**

### **Did You Know?**

**Some cases of pneumothorax are termed spontaneous because of the absence of underlying contributory conditions. In these cases forceful coughing or a bleb rupture in the lung can result in air in the pleural space and the need for a chest tube.**

## Contraindications to Chest Tube Insertion

There are no definite contraindications to a chest tube especially when a patient is experiencing respiratory distress. If multiple adhesions, giant blebs, or coagulopathies are present and the patient is relatively stable, the benefit of chest tube therapy can be carefully weighed against the higher risks of complications for these patients (Doelken, 2010).

In less clear-cut scenarios, it is often helpful to know the amount of lung collapse to better support a decision to insert a chest tube in higher risk patients. Also, a CT scan of the chest may be necessary to guide chest tube placement should the patient have a condition (e.g. lung transplant, multiple loculations from previous pleurodesis) where blind insertion could be an issue (Doelken, 2010).

**More Info:**

**Sometimes a CT scan of the chest may be necessary to guide chest tube placement.**

### **Risk Associated with Chest Tube Insertion**

Chest tube insertion can be performed with basic surgical skills. Risks can be minimized if attention is paid to careful technique and monitoring of the patient for complications. Any potential complications are often outweighed by life-threatening intrapleural collections.

Risks associated with chest tubes include:

- Bleeding at the site is a potential complication; however it is often minor and will likely resolve without intervention (Durai, Hoque, & Davies, 2010).
- Risk of infection (e.g. empyema) and other associated complications increase the longer the chest tube remains inserted.
- Subcutaneous emphysema, a collection of air under the skin, after chest tube placement. Small amounts of air near the chest tube insertion site will likely be absorbed, however, if this air moves to areas of the neck, chest, and face, it requires further attention if painful, though it is mostly a cosmetic issue.
- Lung trauma and perforation of the diaphragm during insertion or removal is possible (Durai, Hoque, & Davies, 2010).
- Bronchopleural fistula, an abnormal connection between an air passage and the membrane that covers the lung, is also a reported complication. In the case of lung trauma or bronchopleural fistula, the chest tube must remain in place until the patient is fully healed.
- Malposition of the chest tube is the most common of all complications, resulting in persistent air and fluid in the pleural space until the malposition is identified and resolved (Doelken, 2010).



Used with permission, Atrium Medical (2013).

### **Test Yourself**

What is a collection of air under the skin called?

- A. Bronchopleural fistula
- B. Empyema
- C. Lung perforation
- D. Subcutaneous Emphysema**



## Chest Tube Overview

To facilitate air and fluid drainage, a chest tube is inserted so that the chest tube eyelets are located inside the chest wall. The catheter is loosely sutured in place. Frequently two catheters are inserted, in which case one is placed near the apex to remove air while the other is placed in the lower part of the chest to remove any pooled blood (Atrium Medical, 2013).

A radiopaque stripe helps the clinician identify catheter placement and location of the “catheter eyes” during X-ray for maximum drainage efficiency.

The size, site, insertion technique, and placement of the chest tube is determined by the indication for the chest tube placement.

## Chest Tube Placement

The position of the chest tube is related to the function that the chest tube performs. If the chest drainage tube is to be used to drain air, the tube is placed anteriorly near the apex of the lung (second intercostal space).

If the function of the tube is to drain fluid, the tube is placed posteriorly near the base of the lung (fifth or sixth intercostal space).

In the case of a hemothorax or when both air and blood is present, a chest tube may be placed at the base of the lung as well as at the apex.

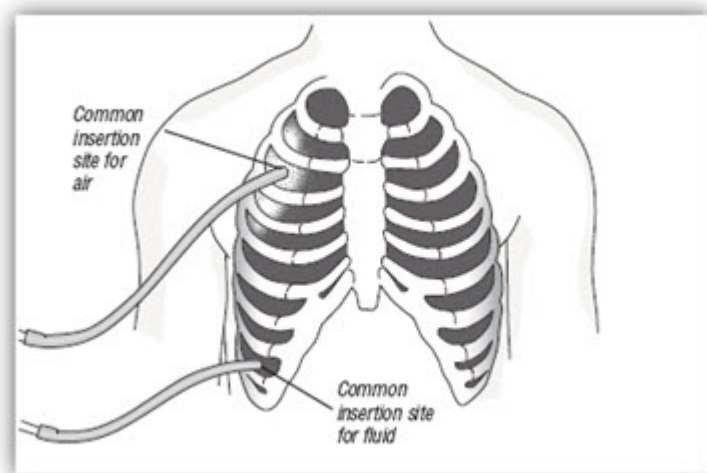

Image provided by Atrium Medical (2013). Used with permission.

## Selecting Appropriate Tube Sizes

It is important for the clinician to determine the most appropriate tube size to use prior to intubation. In general, the following size guidelines can be used to select the most appropriate tube size for the patient, based on the patient's age:

<b>Tube Size</b>	<b>Age of Patient</b>
<b>8FR – 12FR</b>	Infants, young children
<b>16FR – 20FR</b>	Children, young adults
<b>24FR – 32FR</b>	Most popular adult sizes
<b>36FR – 40FR</b>	Larger adult sizes

## **Chest Tube Insertion, Preparation, and Assistance**

### **Where are chest tubes inserted?**

Chest tubes may be inserted at the bedside, operating room, or in intervention radiology depending on the circumstances (Coughlin & Parchinsky, 2006).

### **Do I need consent?**

Before inserting a chest tube, informed consent should be obtained from the patient, a healthcare proxy, or next of kin. The patient should be informed that the tube is necessary to help with his or her breathing; and that it will become easier to breath as the lungs re-expand (Coughlin & Parchinsky, 2006).

What should I tell the patient? It is important for the patient to understand the details of the procedure and that it will be accompanied with local anesthetic and pain medications. The patient should be instructed that he or she may feel pressure in that area (Coughlin & Parchinsky, 2006) but that the goal is to keep him or her as pain-free as possible.

### **Do I give medications?**

When placing a chest tube, medicating the patient is an important step. A mild sedative and a pain medication would be appropriate in this type of situation. Some physicians even prefer moderate or conscious sedation (which requires specific training and competencies) (Coughlin & Parchinsky, 2006).

### **What else should I do?**

If the patient is not intubated, provide oxygen. Keep patient supine with the arm of the affected side above the head. During the procedure, be sure to monitor cardiac rhythm as poor oxygenation may cause an arrhythmia.

### **What supplies do I need?**

The physician will also need equipment for the procedure. Most hospitals keep these supplies together in a thoracotomy tray. Follow your hospital policy and procedure. If your hospital does not, a physician will need supplies such as: injectable lidocaine to numb the site locally, an antiseptic to clean the skin, sterile gloves, a scalpel and hemostats for insertion, a chest tube, suture material when the chest tube is in place, and sterile dressing materials after the tube has been secured (Durai, Hoque, & Davies, 2010).

### **What do I do when the chest tube is inserted?**

When the chest tube has been inserted in the pleural space, the physician will connect the chest tube to

the chest drainage unit. The chest drainage unit should be previously set to the specific levels.

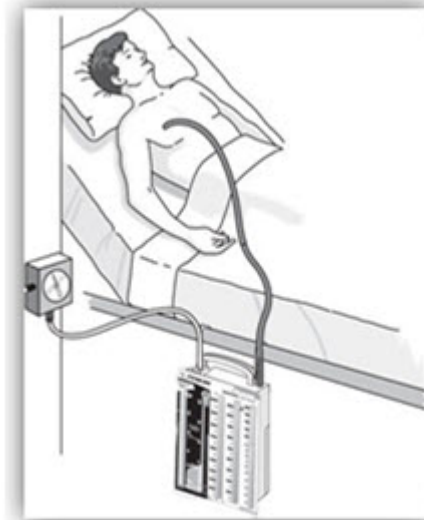

Used with permission, Atrium Medical Corporation, 2010

## The Basics of Chest Drainage Units (CDUs)

### The Basic Operating System

A chest drainage unit is a device used to collect chest drainage (air, blood, effusions), and connects to the end of the chest tube. Most commonly, drainage devices use a single unit that has three chambers, based on the old three-bottle system. The three chambers each provide separate functions of:

- Fluid collection
- Water seal (which serves as a simple one-way valve)
- Suction control

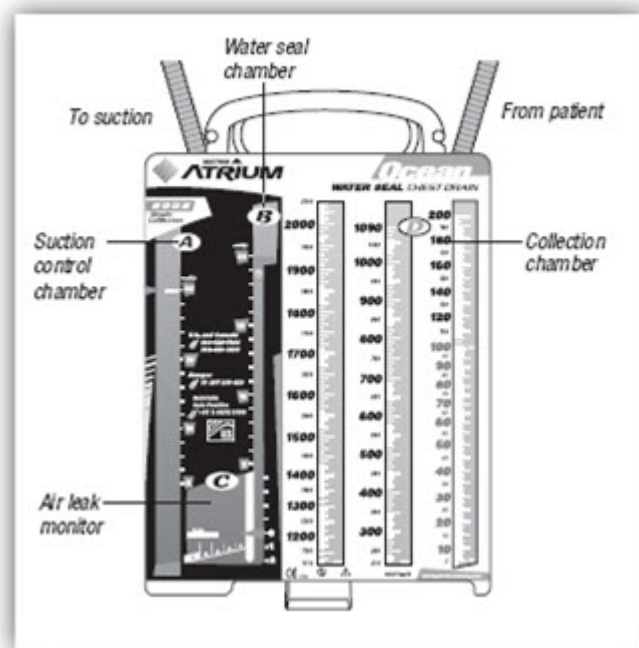

Wet suction chest drainage unit. Image provided with permission from Atrium Medical (2013).

### Did You Know?

**An example of a wet suction control unit is the Pleur-evac®**

## **Fluid Collection**

In a traditional water seal operating system, fluids drain from the patient directly into a large collection chamber via a 6-foot patient tube. As drainage fluids collect in this chamber, the nurse records the amount of fluid that collects on a specified schedule.

## **Water Seal**

The second chamber functions as an underwater seal (UWS), which is a one way valve that allows air to exit the chest and prevents air returning to the patient. Air bubbling through the water seal chamber intermittently is normal when the patient coughs or exhales, but if there is continuous air bubbling in the chamber, it can indicate a leak that should be evaluated. The water seal chamber is connected in series to the collection chamber, and allows air to pass down through a narrow channel and bubble out through the bottom of the water seal. Since air cannot return to the patient, an UWS is considered one of the safest ways of protecting the patient, in addition to being a very useful diagnostic tool.

The UWS column is calibrated and acts as a water manometer for measuring intrathoracic pressure. As changes in intrathoracic pressure occur, fluctuation in the water level can be observed in this calibrated column. Such fluctuations provide the clinician an indication of how the patient is progressing.

## **Suction Control**

The use of suction helps overcome an air leak by improving the rate of air and fluid flow out of the patient. The simplest and most cost effective means of controlling suction is by using a suction control chamber, which is an atmospherically vented section containing water and is connected in series with the water seal chamber and collection chamber.

By adding or removing water in the suction control chamber, the chest drain effectively controls the amount of suction imposed on the patient. The lower the water content, the lower the imposed suction. The higher the water level, the higher the imposed suction.

## **Types of Chest Drainage Units**

In addition to the 3 chamber drainage device previously discussed, there are now newer drainage devices available that eliminate the UWS by using a mechanical check-valve, or a mechanical regulator to regulate the suction pressure.

Systems which employ a mechanical check-valve and a mechanical regulator are known as dry systems, whereas systems that retain a UWS but use a mechanical regulator are called wet-dry systems. Systems which use a water seal and water column regulator are called wet systems.

### **See below for Advantages & Disadvantages of a Dry System**

Dry systems are safer, as wet system devices can tip over and spill. In addition, dry suction control systems provide other advantages, such as higher suction pressure levels, easier set-up, quiet operation without continuous bubbling noise, and the absence of fluid that can evaporate, which would decrease the amount of suction applied to the patient.

A drawback to any mechanical one-way valve is that it does not provide the same level of patient assessment information as a wet system device, as the clinician cannot see changes in the water level

reflecting pressure changes in the chest.

## Essential Differences between Wet and Dry Suction Control Systems

Wet suction control systems regulate suction pressure by the height of the column of water in the suction control chamber. The amount of negative pressure that is transmitted to the patient's chest is determined by the height of water in this chamber, not the level of vacuum set on regulator.

Dry suction control systems regulate suction pressure mechanically rather than with a column of water.

## Setting Up a Traditional (Wet) Water Seal System

The nurse will need to set up the chest drainage unit according to the manufacturer's instruction and the type of chest drainage unit used.

With a tradition water seal system, follow these steps:

### Step 1:

Fill the water seal chamber to the specified level from the manufacturer (which is usually the 2 cm mark).

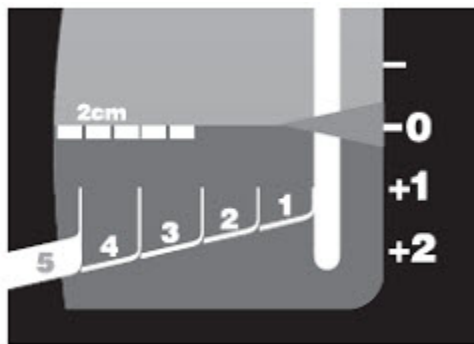

**Step 1: Filling the water seal chamber.** Image used with permission, Atrium Medical, 2013

### Step 2:

Fill Suction Control. The physician will order the amount of suction (e.g., Chest tube to - 20 cm H<sub>2</sub>O). The nurse would then fill the suction control chamber with sterile water to the water level that is marked, -20 cm H<sub>2</sub>O. This level is then documented.



**Step 2: Filling the suction control.** Image used with permission, Atrium Medical, 2013

### Step 3:

Patient Connection. Remove patient tube connector cap and insert stepped connector into patient catheter. Remove the connector for "Y" connector insertion. If desired, use of nylon bands around catheter and patient tube connections will provide added security and assure an air-tight connection.

Material Protected by Copyright

The chest drain should be connected to the patient prior to initiating suction.

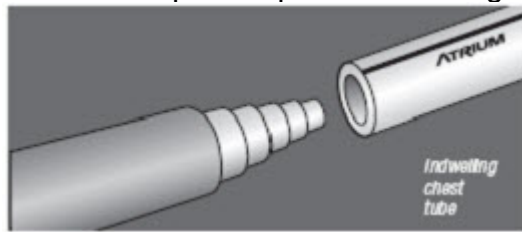

**Step 3: Patient connection. Image used with permission, Atrium Medical, 2013**

**Step 4:**

Applying suction. The tubing on the suction control chamber is attached to the wall suction. The nurse should start with a lower suction level and gradually increase suction until a gentle bubbling in the suction control chamber is noticed. Adjust the suction control stopcock or suction control source as needed to increase or decrease suction control bubbling. To operate the suction container at -20 cm H<sub>2</sub>O, wall suction must have at least -80 mm Hg of vacuum.

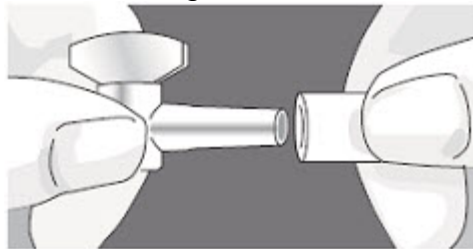

**Step 4: Applying suction. Image used with permission, Atrium Medical, 2013**

**Step 5:**

Open suction control stopcock. The suction control stopcock conveniently regulates vacuum to the chest drain. It provides control of suction bubbling and allows efficient use with any unregulated suction source. The stopcock must be on for initial system setup and should not be turned off during patient use.

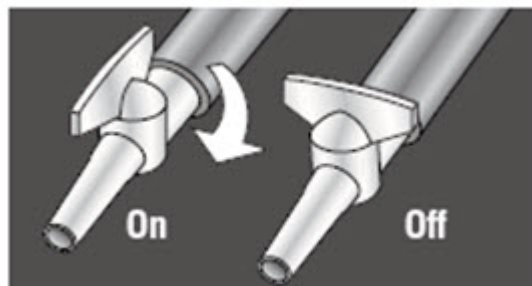

**Step 5: Open suction control stopcock. Image used with permission, Atrium Medical, 2013**

**Step 6:**

Placement of unit. For optimum drainage results, always place the chest drain below the patient's chest in an upright position. To avoid accidental knock-over, it is prudent to swing the floor stand open for secure placement on floor or to hang the system bedside if hangers are provided.

### **Setting Up a Dry Suction Water Seal System**

In recent years, there has been an advancement in technology and there is now dry suction water seal chest drainage system. The steps are minimally different when setting one up:

1. Fill the water seal chamber to the specified level from the manufacturer (which is usually the -2 cm

mark).

2. The physician will order the amount of suction (e.g., Chest tube to -20 cm H<sub>2</sub>O). Using the dial, place the arrow at the correct amount of suction and document.
3. The tubing on the suction control chamber is then attached to the wall suction. The nurse should start with a lower suction level and gradually increase suction until a gentle bubbling in the suction control chamber is noticed. To operate the suction container at -20 cm H<sub>2</sub>O, wall suction must have at least -80 mm Hg of vacuum.

### Did You Know?

Since there is no bubbling in the dry suction control chamber, the orange bellows are used as a visual indicator of suction operation.



**Dry suction Water Seal System. Used with Permission from Atrium Medical ( 2013).**

## **Occlusive Dressing**

The type of dressing applied after chest tube insertion often differs with each facility so it is important to be familiar with and follow your facility policy.

All chest tube dressings should be an occlusive, air tight dressing to prevent air leaks.

Steps to applying a chest tube dressing:

- Always use sterile technique when applying a chest tube dressing.
- Slide a pre-slit 4X4 around the chest tube on the skin around the tube.
- Following the slit drainage pad, place an un-slit 4X4 on top.
- With a 3-4 inch tape, secure the dressing with an airtight seal.
- Frequency of dressing changes should be done per hospital policy. Note any redness around the insertion site, purulent drainage, odor, or crepitus (Coughlin & Parchinsky, 2006).

In order to keep the dressing occlusive and to avoid an air leak, tape all the connections from the insertion site of the patient to the chest drainage unit.

A chest x-ray should be ordered to confirm tube position and lung re-expansion. After the chest tube is in place, the nurse must document the details of the procedure.

### Did You Know?

**The skin around the insertion site must be kept clean and dry at all times to prevent skin breakdown and infection. The risk to the surrounding skin depends on the type and volume of drainage.**

### **Skin Assessment**

The insertion site should be regularly checked for any skin breakdown or subcutaneous emphysema (SCE). SCE can occur when air or CO<sub>2</sub> is trapped in the subcutaneous tissues, and frequently occurs on the face, neck, or chest.

A physical assessment will reveal edema of the affected area along with subcutaneous crepitus (crackling sensation under the skin during palpation). While palpating the involved area, use a skin marker to identify its borders. This will help you determine whether the SCE is progressing or resolving (Moye, 2010).

In most cases, the affected tissues slowly absorb the SCE after the underlying cause is identified and treated. When reabsorption occurs, air can move from the insertion site into the face, chest or neck and may displace the chest tube (Moye, 2010).

Air under the skin is usually painless, and feels spongy; some people describe it as feeling "Rice Krispies" under the skin. If it becomes painful, the physician should be notified.

### Chest CT Scan of a patient with severe subcutaneous emphysema.

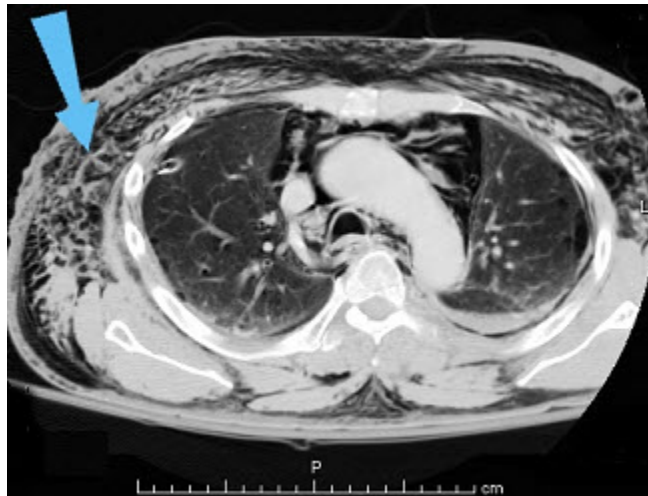

Image provided courtesy of Wikipedia Creative Commons Attribution

*Please note!*

**Subcutaneous emphysema is also known as crepitus or Sub Q Air.**

### **Patient Assessment**

The patient and the chest drainage unit require additional monitoring while the chest tube is in place. Depending on the patient's condition, a nurse should check the chest tube and monitor it at least once  
Material Protected by Copyright



every 8 hours or more (depending on the patient's condition) (Roman, & Mercado, 2006).

In the hospital, patient assessment is foremost and should concentrate on:

- Vital signs
- Respiratory rate
- Respiratory status
- Respiratory pattern
- Respiratory depth
- Ease of respiration
- Oxygen saturation
- Check for subcutaneous emphysema (crackling sensation under the skin during palpation)

Signs of respiratory distress include tachypnea, dyspnea, shortness of breath, tachycardia, decreased or absent breath sounds, and use of accessory muscles of respiration.

**More Info:**

**It is important to have a baseline assessment to compare future assessments, establish trends, and evaluate current patient condition.**

### **Monitoring the Chest Drainage Unit**

Monitoring the chest drainage unit is important to make sure it is functioning correctly. When monitoring the unit, it is important to regularly check:

- Water levels in the chest drainage unit. The water may evaporate over time, and may need to be refilled periodically.
- The connection source to ensure that the chest drainage unit is suctioning properly. Adequate suction is confirmed by noting a gentle bubbling in the suction control chamber (Rushing, 2007).

The suction control stopcock can be adjusted to increase or decrease suction control bubbling.

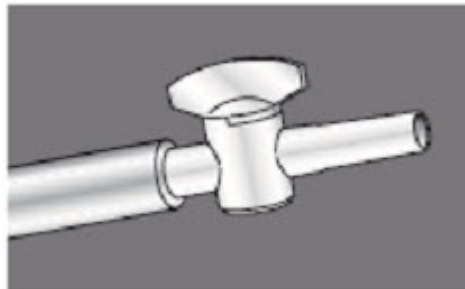

Suction Control Stopcock. Image provided by Atrium Medical (2013).

*Please note!*

**A nurse must validate that the system functions correctly every shift on the flowsheet or the nurse's notes.**

### **Monitoring Intrathoracic Pressure**

If a chest drainage unit is not connected to suction, it is utilizing gravity to drain fluid from the chest cavity. To accurately read intrathoracic pressure when using gravity only (no suction), the clinician

should read directly from the water seal.

A rise in the water seal indicates that negative pressure is present in the pleural space (this confirms that the patient is healing). On the other hand, bubbling indicates positive pressure (air leak).

When recording intrathoracic pressure in a unit on suction: Add the readings of suction control chamber plus the level of the water seal chamber. For Example:  $-20\text{cmH}_2\text{O} + -5\text{cmH}_2\text{O} = -25\text{cmH}_2\text{O}$  intrathoracic pressure.

## Tidaling

With a chest tube in the pleural space, the water level should fluctuate in the water seal chamber. This is known as tidaling, and should correspond with respiration.

When there is no air leak, the water level in the water seal chamber should rise and fall with the patient's respiration.

During spontaneous respiration, the water level will rise during inhalation and fall during exhalation.

If the patient is receiving positive pressure ventilation, the oscillation will be just the opposite. If the lung is re-expanded, tidaling may not be present (Rushing, 2007).

### More Info:

**If tidaling doesn't occur, the tubing could be kinked or clamped, or a dependent tubing section may have become clogged with fluid buildup (Bauman & Handley, 2011).**

## Sampling the Pleural Fluid

While the chest tube is in place, the physician may order tests on the pleural fluid for various reasons.

As needed, sample fluids from the tubing with a 20 to 24 gauge needle after cleaning the tubing with an alcohol swab or betadine swab.

With newer chest drainage units, there are needleless ports to remove fluid immediately before the fluid enters the chest drainage unit (Atrium Medical, 2010).

## Drainage

Depending on the hospital, the nursing unit, and the patient's condition, it is necessary to monitor and document chest drainage every four to eight hours minimally or as condition warrants:

- Closely monitoring the output will enable the nurse to notify the physician if there is excessive output.
- To assess drainage level, mark the drainage level on the outside of the drainage collection chamber in hourly or shift increments with the date and time. Record the output information on the flowsheet to provide a reference point for future measurements.
- In the nurse's note or flowsheet, a description of the drainage color will also help healthcare providers to guide their care. For example, with a hemothorax, the color should change from bloody to straw color (sanguinous to sero-sanguinous to serous). Accurate documentation will facilitate early identification of any changes in the patient's condition related to the chest tube.
- Significant changes should be reported to the physician. Examples of this are: the drainage color changed from serous to bloody or drainage output was greater than 100 ml in one hour when the

output was normally 10 ml in 12 hours or there is increasing bloody drainage greater than 100 ml in one hour.

(Coughlin & Parfchinsky, 2006).

If there is no drainage inform the physician and anticipate an order for a chest x-ray to see if the lung has re-expanded. If it has not re-expanded, the chest tube may be displaced or it may be clogged. The physician should be notified so that the patient can be reassessed. The physician may order a CT scan of the chest to check placement or may decide to place a new chest tube (Doelken, 2010).

## Air Leaks

Assess the patient for an air leak. It is important to rectify any air leaks because an airtight system reestablishes negative pressure and permits the lungs to expand effectively.

Assessing for an air leak: Clamp off suction for one minute. An air leak is present if there is constant bubbling in the water-seal chamber.

An air leak alerts the nurse that he or she must assess for the location of the leak by checking the connections from the chest drainage unit to the insertion site.

If there is excessive, continuous bubbling in the water-seal chamber, there is most likely a large air leak. Starting from away from the patient and going towards the patient, check all connections. Lastly, change the dressing and make sure there is good seal with the dressing around the insertion site.

If it is the pleural space that is leaking, intermittent bubbling with respiration is normal. This will resolve as the lung re-expands. Therefore, when a pneumothorax is the indication for the chest tube, an air leak is to be expected; yet, should decrease with patient improvement (Atrium Med, 2010).

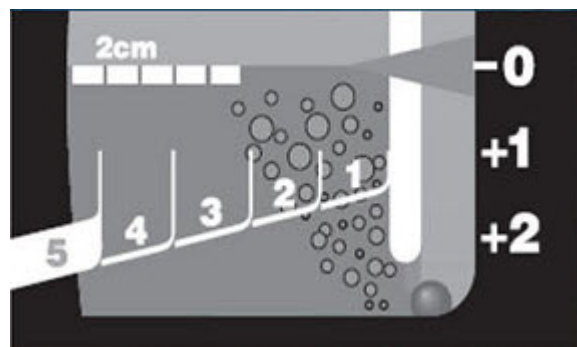

Used with permission, Atrium Medical Corporation, 2010

## Chest Tube Maintenance

Keep all tubing patent and free of kinks or obstructions. Dependent loops with the chest tube tubing should be avoided since they obstruct chest drainage into the collection system and increase pressure within the lung.

The tubing should also never dangle; coil it on the bed and anchor tubing when securing the chest tube.

It is acceptable for the nurse to gently milk the tubing when a visible clot or obstructing drainage is in the tubing by squeezing hand over hand along the tubing and releasing the tubing between squeezes (Coughlin & Parchinsky, 2006). However, excessive chest-tube manipulation should be avoided, as

this can create negative pressures in the tube and does little to maintain chest-tube patency. If you see visible clots, squeeze hand-over-hand along the tubing and release the tubing between squeezes to help move the clots into the CDU.

**More Info:**

**There is no benefit from stripping the tubing because it can result in transient high negative pressures in the pleural space.**

## Clamping the Chest Tube

**Never** clamp the chest tube unless the physician orders it or when a nurse is changing the chest drainage unit.

If the patient on water suction is going off the unit for a procedure/diagnostic test or being transferred, put the chest drainage unit to under water seal (UWS), which is a one-way valve which allows air to exit the chest and prevents air returning to the patient under normal conditions.

When ambulating a patient, ensure that the drainage unit is carried at a level below the patient's chest. Ensure that the tube is functioning & the connections are secure. Also ensure that the UWS is at least 20cmH<sub>2</sub>O below the patient's fluid level.

**Did You Know?**

**When it is medically necessary to clamp the chest tube, clamp for no longer than one minute, to prevent increased pressure within the lung.**

## Dislodgement or Disconnection

If the chest tube accidentally falls out, instruct the patient to perform the Valsalva maneuver.

At end-expiration immediately cover the insertion site with vaseline gauze (if indicated by your hospital), a dry sterile dressing, and occlusive tape (Pruitt, 2008).

In the event of chest-tube disconnection with contamination, you can submerge the tube 1" to 2" (2 to 4 cm) below the surface of a 250-mL bottle of sterile water or saline solution until a new CDU is set up. This establishes a water seal, allows air to escape, and prevents air reentry (Bauman & Handley, 2011).

The nurse should immediately call the physician and prepare for re-inserting of the chest tube. While informing the physician, place oxygen on the patient and sit patient in high-Fowlers.

It is imperative that the nurse evaluate the patient for a life threatening situation, such as a tension pneumothorax. If medically necessary per the physician's orders, set up the chest drainage unit and gather the thoracotomy tray while monitoring the patient's vital signs.

**More Info:**

**Check and follow your facility's P&P regarding chest tube disconnection.**

## Test Yourself

What is a Valsalva maneuver?

### Answer:

A Valsalva maneuver occurs when a person tries to exhale forcibly with a closed glottis (the windpipe) so that no air exits through the mouth or nose. This may occur during strenuous coughing, straining during a bowel movement, or lifting of a heavy weight. The Valsalva maneuver impedes the return of venous blood to the heart. Initially during a Valsalva, intrathoracic pressure becomes very positive due to the compression of the thoracic organs by the contracting rib cage.

## Changing the Chest Drainage Unit

If the drainage collection chamber is full, set up a new chest drainage unit:

- Instruct the patient to exhale and hold his or her breath (perform the Valsalva maneuver).
- Clamp the chest tube with a padded Kelly clamp about one to two inches from the patient.
- Place a second clamp distally. Aseptically, disconnect tubing from old chest drainage unit and connect to the new chest drainage unit.
- When completed, remove clamps within one minute and have your patient breathe normally.
- At the end of changing the chest drainage unit, secure all connections with tape.

(Atrium Med, 2010)

## Test Yourself

It is not necessary to clamp the chest tubes if the nurse can change the chest drainage unit within **one minute**.

- A. True
- B. False**

## Patient Education

When a patient has a chest tube, the patient will require specific instructions to help re-expand the lung:

1. The nurse should teach turn cough deep breathing and incentive spirometry.
2. If the patient splints with coughing or has decreased breath sounds, more analgesic is often needed so that the patient can be pain free while taking a deep breath. It is important to evaluate the patient's need for pain medications to prevent hypoventilation, compliance, atelectasis, and pneumonia. The nurse should monitor the patient's subjective pain level with the facility approved pain scales and vital signs. The patient should receive prescribed pain medications as ordered. If a patient splints while coughing and is not taking deep breaths due to high pain levels, the lung will not be able to re-expand.
3. Getting a patient out of bed or encouraging ambulation with the physician's order also helps. With movement, pain medications are often required in order for a patient to tolerate these activities (Rushing, 2007).

## Prior To Discontinuation of the Chest Tube

Certain important criteria must be met prior to removing a chest tube and the underlying condition that required the use of the chest tube should be resolved.

- If the chest tube was used to drain fluid, the lung should be fully expanded and the daily fluid output should be less than 100 to 200 ml/day.

- If the chest tube was placed to respond to a pneumothorax, the lung should be fully expanded and an air leak should not exist during suction or coughing (Doelken, 2010).

After the criteria is met, certain steps should follow:

- The physician will order for the chest tube to be placed on water seal (if it hasn't been order already).
- A follow-up chest x-ray is needed to make sure the lung is re-expanded on radiograph. The patient should be monitored for respiratory complications. A physician should be notified if there is any change in respiratory status.
- If the patient remains stable and the x-ray confirms lung expansion, the chest tube may be discontinued (Doelken, 2010).

## Did You Know?

See below to view a list of supplies needed to remove a chest tube:

- Suture removal kit
- Vaseline gauze
- 4X4
- Tape
- Sterile gloves
- Sutures (optional)
- Gloves

## Discontinuation of the Chest Tube

- The need for analgesia prior to discontinuing the chest tube should be considered.
- Inform patient about the steps that will be taken.
- Sit patient in semi-Fowlers or on his or her unaffected side.
- In order to keep the linens clean, the nurse or physician should drape the bed linen with protective pads.
- The physician should use hand hygiene and put on gloves then clamp drainage tubing.
- With nonsterile gloves, the nurse or physician will remove the old dressing then don sterile gloves.
- An aseptic technique should be used when removing the chest tube.
- The physician will instruct the patient to slowly exhale while the chest tube is removed on end-exhalation. If the patient can perform the Valsalva maneuver, this would be an opportune time for the physician to remove the chest tube.
- Often the physician will close the wound with purse string suture which is usually already present, but sometimes it is necessary to suture the site.
- Place an occlusive dressing (vasoline gauze, 4X4, and tape) over site and time, date, and initial the dressing. The nurse will need to follow-up to make sure a chest x-ray is obtained after the procedure.

## Documentation

See each box below for more information.

### **Documenting Chest Tube Placement:**

The following items must be included in a comprehensive documentation post chest tube placement:

- Vital signs before and after the procedure.
- Chest tube size and insertion site.
- Physician inserting the chest tube.
- Drainage present (and if it was sent for culture).
- Tolerance to procedure.
- Medications given.
- Results of the chest x-ray post chest tube insertion.
- Patient and family teaching (Pruitt, 2008).

### **Documentation Every Shift:**

- Describe of drainage (serous, sanguineous, serosanguinous).
- Date and time of the drainage amount on the chest drainage unit.
- Total amount of drainage on intake/output flowsheet.
- Type and amount of suction.
- Date/time of dressing change. Follow hospital policy on frequency. Note any redness around the insertion site, any purulent drainage, any odor, or crepitus.
- Air leak presence or absence.
- Respiratory status.
- Patient or family education (Pruitt, 2008).

### **Documentation After Chest Tube Discontinuation:**

- All patient and family education should be discussed.
- The vital signs and assessments before and after the procedure are documented.
- Information about the procedure such as date, time, and physician performing the procedure, should be documented.
- State that the sterile, occlusive dressing is intact.
- Note how the patient tolerated the procedure and what medications (if any) were used (Pruitt, 2008).

### **Test Yourself**

After the chest tube is in place, the nurse must document the details of the procedure.

- A. True**
- B. False

### **An Alternative to Chest Drainage Units**

The Heimlich chest drainage valve is an alternative method of draining the chest cavity, without using a chest drainage unit. Also known as a flutter valve, the Heimlich valve connects to chest tubing and allows fluid and air to pass in one direction only. The valve, which functions in any position, need never be clamped, and regulated suction can be attached to it if necessary. The valve drains into a plastic bag that can be held at any level, allowing the patient undergoing chest drainage to be ambulatory simply by carrying the bag.

This valve is most commonly used to help remove air from a pneumothorax. The end of the drainage tube is placed inside the chest cavity, within the air or fluid to be drained. The flutter valve is placed in the appropriate orientation and the pneumothorax can be evacuated from the patient's chest.

However, there are several potential problems with these valves:

### Clogging of the tube

The chest tube can easily clog, and this may result in a recurrence of the pneumothorax or subcutaneous emphysema, or lead to empyema (accumulation of pus).

### Fluid Leakage

Is fairly common with the use of flutter drains. An alternative solution is to attach a sputum trap to the valve, thus providing a reservoir to capture the draining fluid, or use a chest drainage unit.

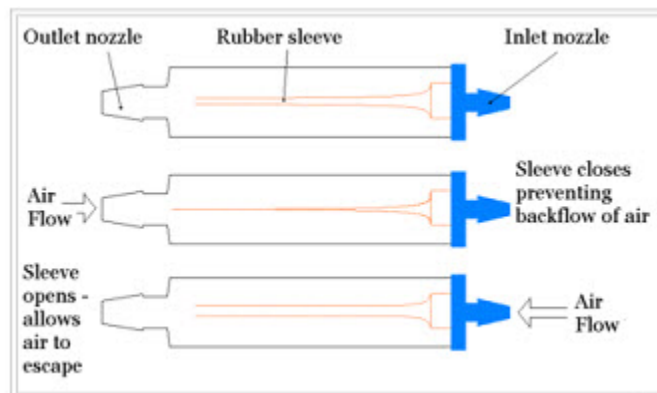

The Heimlich Chest Drain. Orinoco (2008). Image provided under the Free Documentation License. [http://en.wikipedia.org/wiki/Flutter\\_valve](http://en.wikipedia.org/wiki/Flutter_valve)

### Case Study #1

A patient with a history of COPD and smoking comes into the emergency department complaining of sharp pain in the left side of his chest. He was complaining of sudden short of breath and pain while breathing. Vital signs: RR 40; HR 120; BP 90/40; and oxygen saturation of 82%. Respiration is fast and shallow. Upon physical assessment, the patient has absent breath sounds on the left. What are the next steps?

#### See below for next steps:

- Place oxygen on the patient and sit him up to a high Fowlers position.
- Immediately page the physician as this could result in an emergency.
- Obtain an STAT x-ray if not already done.
- Get a thoracotomy tray to the bedside.
- Set up chest drainage unit.
- Explain to the patient what is happening and the need for the chest tube. Have the physician obtain consent.
- Give pain medications as ordered by the physician.
- Assist with chest tube insertion.
- After the chest tube is placed, tape all the connection sites.
- After the chest tube is placed, do a follow-up x-ray.



- Document procedure, including patient's tolerance, site, and any difficulties during insertion in the nurses progress notes.

## Case Study #2

A patient received a chest tube from a complication while the physician was inserting a subclavian central line in the intensive care unit. There has been no drainage in the chest drainage unit for 48 hours. A chest x-ray from the morning showed that the lungs have re-expanded. The patient has stable vital signs: HR 72; BP 120/55; RR 14; and oxygen saturation of 99% on one liter nasal cannula. The arterial blood gas results are: pH 7.40; CO<sub>2</sub> 40; pO<sub>2</sub> 150; HCO<sub>3</sub> 24. The chest tube has been on water seal for two days. What are the next steps?

### See below for next steps:

- Consider need for analgesia prior to discontinuing the chest tube.
- Gather your supplies: suture removal kit, Vaseline gauze, 4x4, tape, sterile gloves, sutures (optional), and gloves. Use an aseptic technique when removing the chest tube.
- Talk to the patient about what will happen.
- Sit patient in semi-fowlers or on his unaffected side.
- Drape bed linen with protective pads.
- Use hand hygiene and put on gloves.
- Remove old dressing then don sterile gloves.
- Remove the chest tube slowly on exhalation.
- Suture the site (often the physician will close the wound with purse string suture which is usually already present).
- Clamp drainage tubing.
- Put occlusive dressing (Vaseline gauze, 4x4, and tape) over site. Time, date, and initial dressing.
- Chest x-ray after chest tube removal.
- Reposition patient frequently after procedure. This will help prevent complications from immobility and retained secretions.

## Case Study #3

A patient was in a motor vehicle accident and suffered a right pneumothorax that required a chest tube placement in the emergency department. The physician orders a CT Scan to evaluate further abdominal issues from the impact. On transferring a patient over to the CT Scan table, the patient becomes short of breath. He is conscious but gasping for breath. As the nurse approaches the patient, he notices that the chest tube has been dislodged and is now on the floor. What are the next steps?

### See below for next steps:

- You realize that this is an emergent situation and stay calm as this could result in the patient having a tension pneumothorax.
- Place patient in high Fowlers.
- Grab sterile 4x4 dressing and Vaseline gauze.
- Have the patient perform Valsalva maneuver (deep breath and forcefully exhale to force the air from the pleural space and the lung will re-expand). At end expiration, place Vaseline gauze and a 4x4 dressing over insertion site. (Per hospital policy and procedure).

- Notify physician immediately.
- Continue to assess patient for signs or symptoms of a tension pneumothorax.
- Give patient oxygen.
- Set up a chest tube tray.
- Monitor vital signs closely.

## Conclusion

It is important to know the signs and symptoms of a patient that is experiencing respiratory distress.

Patients who are diagnosed with a pneumothorax, tension pneumothorax, hemothorax or any other condition that involves inadequate inflation of the lung may require a chest tube.

When managing the care of patients who have chest tubes it is important to fully understand what to do in case problems arise.

It is also important to be able to assess when the chest tube is ready to be discontinued.

Nurses and other healthcare professionals who are responsible for the safe delivery of care should be knowledgeable about respiratory pathophysiology, signs of respiratory compromise, and the care and management of interventions that may be utilized to ensure adequate respiration.

## Disclaimer

This publication is intended solely for the educational use of healthcare professionals taking this course, for credit, from RN.com, in accordance with RN.com [terms of use](#). It is designed to assist healthcare professionals, including nurses, in addressing many issues associated with healthcare. The guidance provided in this publication is general in nature, and is not designed to address any specific situation. As always, in assessing and responding to specific patient care situations, healthcare professionals must use their judgment, as well as follow the policies of their organization and any applicable law. This publication in no way absolves facilities of their responsibility for the appropriate orientation of healthcare professionals. Healthcare organizations using this publication as a part of their own orientation processes should review the contents of this publication to ensure accuracy and compliance before using this publication. Healthcare providers, hospitals and facilities that use this publication agree to defend and indemnify, and shall hold RN.com, including its parent(s), subsidiaries, affiliates, officers/directors, and employees from liability resulting from the use of this publication. The contents of this publication may not be reproduced without written permission from RN.com.

Participants are advised that the accredited status of RN.com does not imply endorsement by the provider or ANCC of any products/therapeutics mentioned in this course. The information in the course is for educational purposes only. There is no “off label” usage of drugs or products discussed in this course.

You may find that both generic and trade names are used in courses produced by RN.com. The use of trade names does not indicate any preference of one trade named agent or company over another. Trade names are provided to enhance recognition of agents described in the course.

Note: All dosages given are for adults unless otherwise stated. The information on medications contained in this course is not meant to be prescriptive or all-encompassing. You are encouraged to consult with physicians and pharmacists about all medication issues for your patients

## References

- Atrium Medical (2010). Chest drainage competency manual. Retrieved August 1, 2010, from [www.atriummed.com](http://www.atriummed.com)
- Atrium Medical, (2013). A Personal Guide to Managing Chest Drainage. Retrieved September 9, 2013 from: [http://www.grandcountyems.com/Education/Equipment\\_Manuals/BlueHandbook.pdf](http://www.grandcountyems.com/Education/Equipment_Manuals/BlueHandbook.pdf).
- Bauman, M. & Handley, C. (2011). Chest Tube Care: The More You Know, The Easier It Gets. *American Nurse Today*, 6 (9).
- Coughlin AM, Parchinsky C. (2006). Go with the flow of chest tube therapy. *Nursing*; 36(3):36-41.
- Doelken, P. (2010). Tube thoracostomy. Retrieved August 1, 2010, from [www.uptodate.com](http://www.uptodate.com)
- Durai, R., Hoque, H., & Davies, T.W. (2010). Managing a chest tube and drainage system. *AORN*, 91(2), 275-283.
- English, J.C., Leslie, K.O. (2006). Pathology of the pleura. *Clinics in Chest Medicine*, 27(2), 157-180.
- Moye, M. (2010). Understanding subcutaneous emphysema. *Nursing* 2013, 40 (6), p. 64. Retrieved September 19, 2013 from: [http://journals.lww.com/nursing/Fulltext/2010/06000/Understanding\\_subcutaneous\\_emphysema.21.aspx](http://journals.lww.com/nursing/Fulltext/2010/06000/Understanding_subcutaneous_emphysema.21.aspx)
- Pruitt, B. (2008). Clearing the air with chest tubes. *Men in Nursing*, 33-37.
- Respiratory Therapist Cave (2011). Chest tubes and pleural drainage systems. Retrieved August 29, 2013 from: <http://respiratorytherapycave.blogspot.com/2011/10/chest-tubes-and-pleural-drainage.html>
- Roman M, Mercado D. (2006). Review of chest tube use. *Medsurg Nursing*; 15(1):41-43.
- Rushing, J. (2007). Managing a water-seal chest drainage unit. *Nursing* 2007: 12.